

**Laboratories to Explore, Explain
and Expand the Frontiers of Science**

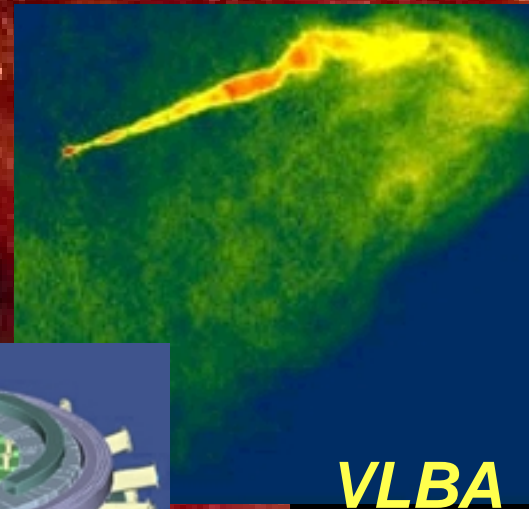

CHANDRA



VLBA



NIF

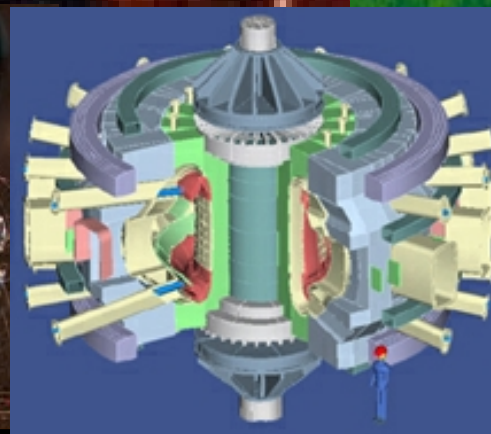

FIRE



HST

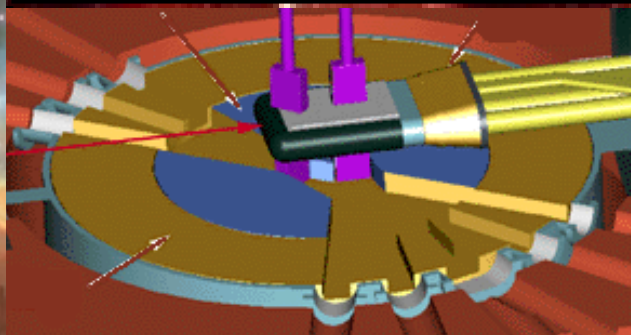

SNS

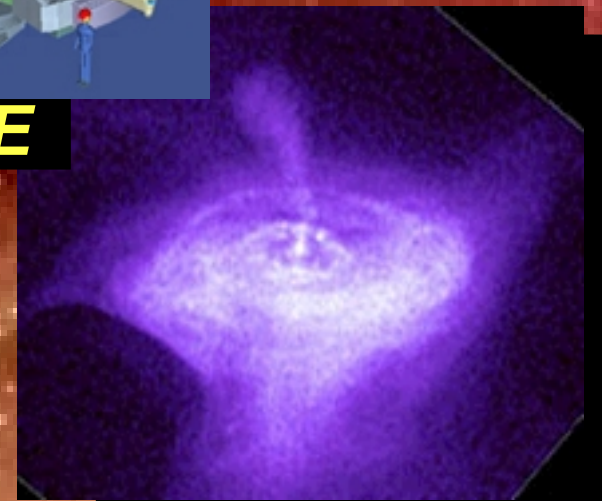

CHANDRA

Fusion Ignition Research Experiment (FIRE)

A Next Step Option for Magnetic Fusion Research

Dale M. Meade
National FIRE Design Study Team

FIRE Physics Workshop
Princeton Plasma Physics Laboratory

May 1, 2000

<http://fire.pppl.gov>

FIRE

Fusion Ignition Research Experiment



Contributors to the FIRE Design Study

FIRE is a design study for a major Next Step Option in magnetic fusion and is carried out through the Virtual Laboratory for Technology. FIRE has benefited from the prior design and R&D activities on BPX, TPX and ITER.

**Advanced Energy Systems
Argonne National Laboratory
Bechtel Technology and Consulting
General Atomics Technology
Georgia Institute of Technology
Idaho National Engineering Laboratory
Lawrence Livermore National Laboratory
Massachusetts Institute of Technology
Oak Ridge National Laboratory
Princeton Plasma Physics Laboratory
Sandia National Laboratory
Stone and Webster
The Boeing Company
University of Illinois
University of Wisconsin**

NSO/FIRE Community Involvement (FY-99)

A Proactive NSO/FIRE Outreach Program has been undertaken to solicit comments and suggestions from the community on the next step.

- Presentations have been made and comments received from:

SOFT/Fr	Sep 98	IAEA/Ja	Oct 98
APS-DPP	Nov 98	FPA	Jan 99
APEX/UCLA	Feb 99	APS Cent	Mar 99
IGNITOR	May 99	NRC	May 99
GA	May 99	LLNL	May 99
VLT-PAC	Jun 99	MIT PSFC	Jul 99
Snowmass	Jul 99	PPPL/SFG	Aug 99
U. Rochester	Aug 99	NYU	Oct 99
U. Wis	Oct 99	FPA	Oct 99
SOFE	Oct 99	APS-DPP	Nov 99
U. MD	Dec 99	DOE/OFES	Dec 99
VLT PAC	Dec 99	Dartmouth	Jan 00
Harvey Mudd	Jan 00	FESAC	Feb 00
ORNL	Feb 00	Northwest'n	Feb00
U. Hawaii	Feb 00	Geo Tech	Mar 00
U. Georgia	Mar 00	PPPL	Mar 00
Naval Postgrad S	Mar 00	U. Wis	Mar 00/Apr00

- The FIRE web site has been developed to make information on FIRE and fusion science accessible and up to date. A steady stream of about 150 visitors per week log on to the FIRE web site since the site was initiated in early July, 1999.

Burning Plasma Physics is Widely Accepted as the Primary Objective for a Next Step in Fusion Research

- Grunder Panel and Madison Forum endorsed Burning Plasmas as next step.
- NRC Interim Report identified “integrated physics of a self-heated plasma” as one of the critical unresolved fusion science issues.
- The Snowmass Fusion Summer Study endorsed the burning plasma physics objective, and that the tokamak was technically ready for high-gain experiment.
- R. Pellat, Chair of the CCE-FU has stated that “the demonstration of a sustained burning plasma is the next goal” for the European Fusion Program.
- SEAB noted that “There is general agreement that the next large machine should, at least, be one that allows the scientific exploration of burning plasmas” and if Japan and Europe do not proceed with ITER “the U. S. should pursue a less ambitious machine that will allow the exploration of the relevant science at lower cost.” “In any event the preliminary planning for such a machine should proceed now so as to allow the prompt pursuit of this option.”

Physics Requirements for Next Step Experiments

Study Physics of Fusion Plasmas (transport, pressure limits, etc.)

Same plasma physics if $\rho^* = \rho/a$, $v^* = v_c/v_b$ and β are equal

Requires $BR^{5/4}$ to be equal to that of a fusion plasma

Study Physics of Burning Plasmas (self heating, fast particle stability, etc)

Alpha heating dominant, $f_\alpha = P_\alpha/P_{\text{heat}} = Q/(Q+5) > 0.5$ for $Q > 5$

Q = function of $n\tau_E T$, e.g., Lawson diagram

$n\tau_E T = B \times \text{function}(\rho^*, v^*, \beta)$ is true in general

$n\tau_E T \sim B \times (BR^{5/4})$, if τ_E is given by ITER98H empirical scaling at fixed beta

Alpha particle confinement requires $Ip(R/a) \geq 9$, $Ip(R/a) \sim BR$

Both objectives require sufficient plasma duration to study the physics.

The Tokamak is Ready for a High-Gain Test

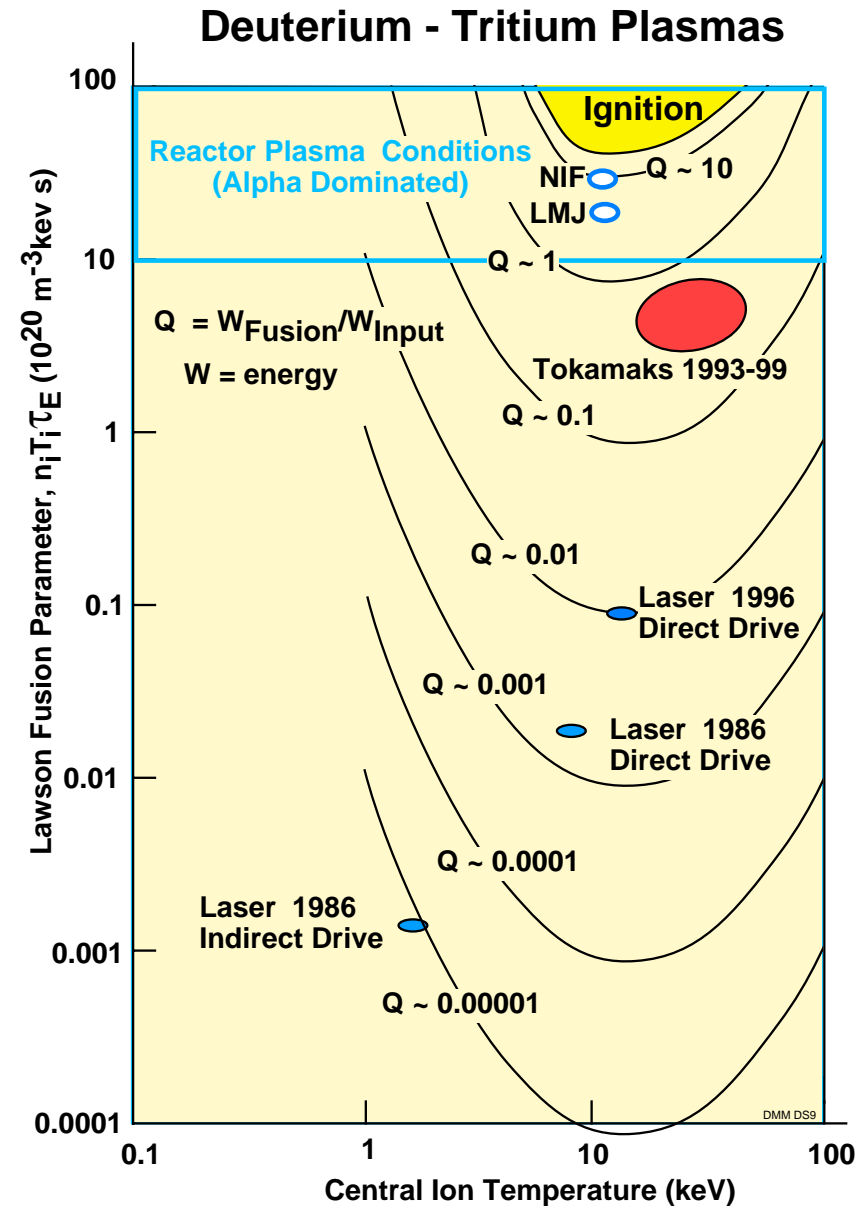
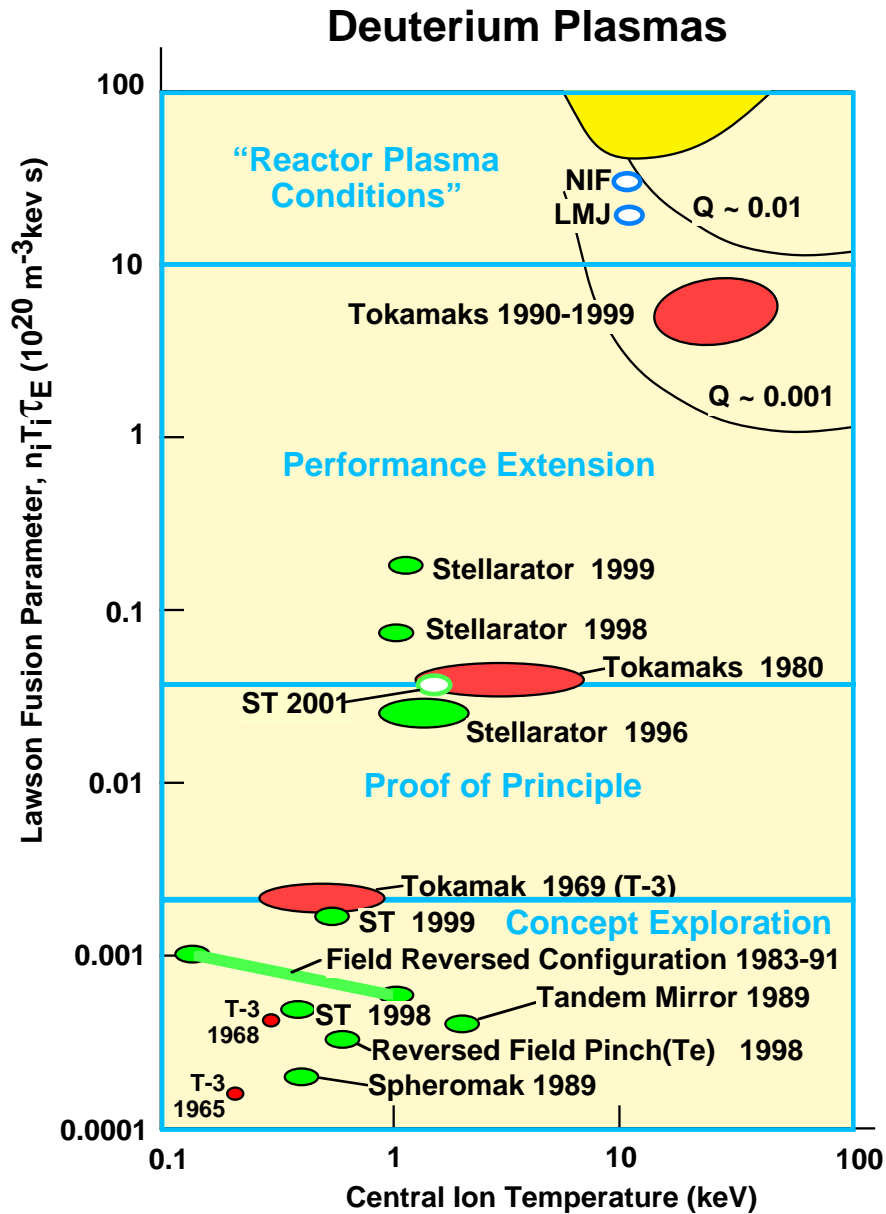

The tokamak is sufficiently advanced to permit the design, construction and initiation of a next step burning plasma experiment within the next decade that could address the fusion plasma and self-heating issues for magnetic fusion.

MFE Experimental Facilities are Needed to Investigate Plasma Science at Fusion Conditions

		Magnetic Fusion	Inertial Fusion
↑		(DEMO) (ITER-RC)	(DEMO) (ETF)
Science Steps	↑	(FIRE, IGNITOR)	NIF*, LMJ* (X-1)
		JET, TFTR, JT-60U, DIII-D, C-Mod, AUG, LHD, W-7X*	Omega-U, NOVA, GEKKO 12, Vulcan, Russian Z
		PLT, DIII, PBX, TFR, Asdex, JFT-2M W-7AS, JIPPT-2 NSTX, MAST MST	Shiva, OMEGA Nike, Super Ashura NOVETTE GEKKO IV (IREs)
	↓	T-3, Many tokamaks Many stellarators Several STs Many Pinches Many Mirrors	AURORA Argus Cyclops JANUS PFBA

> 500 MF exp'ts since 1957 ~100 IF exp'ts since 1970

* Under Construction, () Design Study

The Rosetta Stone for Fusion

	<u>Fusion Energy</u>	<u>Fusion Science</u>
plasma physics	$n\tau_E T$	ρ^*, v^*, β (BR ^{5/4})
burning physics	$Q = P_{\text{fus}}/P_{\text{aux-heat}}$	$f_\alpha = P_\alpha/(P_{\text{aux-heat}} + P_\alpha)$
time	s, min, hr	$\tau_E, \tau_{\text{skin}}, \text{etc}$
flexibility	low	high
availability	high	low
technology	nuclear	enabling

Fusion Science and Fusion Energy

have different languages, metrics, and missions.

Stepping Stones for Resolving the Critical Fusion Plasma Science Issues for an Attractive MFE Reactor

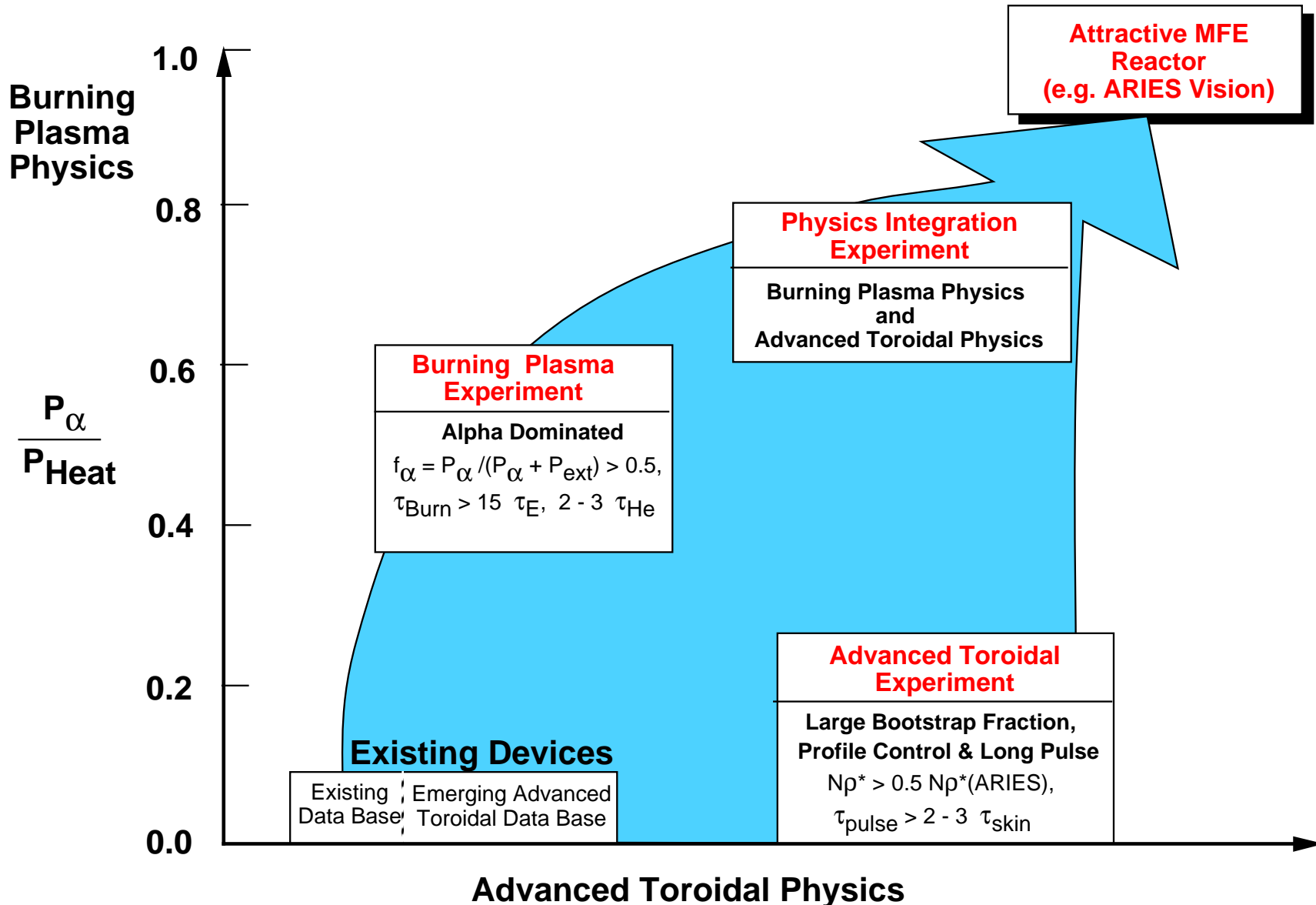

The “Old Paradigm” required three separate devices, the “New Paradigm” utilizes one facility operating in three modes or phases.

Burning Plasma Physics Objectives for a Fusion Ignition Research Experiment (FIRE)

- Explore and understand the physics of alpha-dominated plasmas:
 - Energy confinement scaling with alpha- dominated heating
 - β -limits with alpha- dominated heating
 - Density limit scaling with alpha- dominated heating
- Control alpha- dominated plasmas (e.g., modification of plasma profiles)
- Sustain alpha- dominated plasmas - high-power-density exhaust of plasma particles and energy, alpha ash exhaust, study effect of alpha-heating on the evolution of bootstrap current profile.
- Exploration of alpha- dominated burning plasma physics in some advanced operating modes and configurations that have the potential to lead to attractive fusion applications.
- Understand the effects of fast alpha particles on plasma stability.

Attain, explore, understand and optimize alpha-dominated plasmas to provide knowledge for the design of attractive Magnetic Fusion systems.

The Tokamak is the Most Advanced Magnetic Configuration, and has the Potential to be an Attractive Fusion Reactor

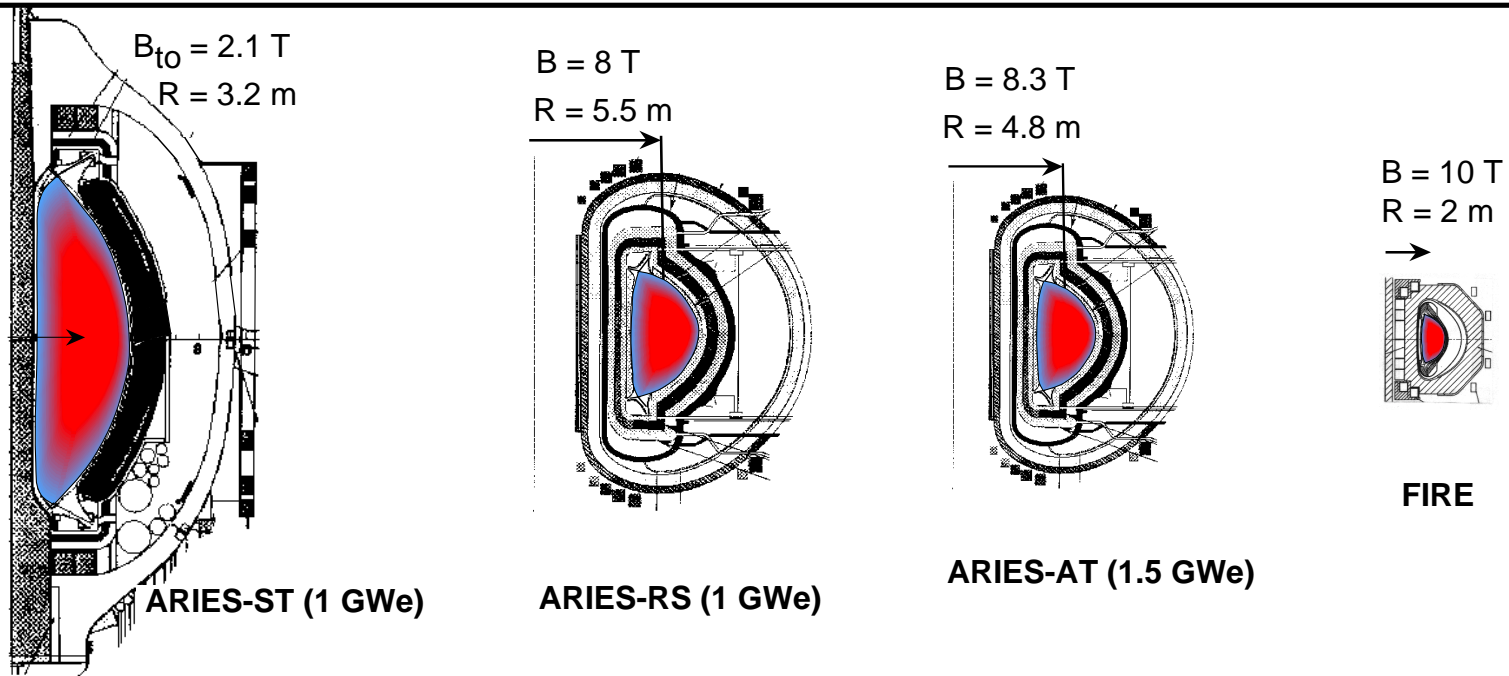

Fusion Metrics	ARIES-ST	ARIES-RS	ARIES-AT*	FIRE
Plasma Volume (m^3)	810	350	220	18
Plasma Surface (m^2)	580	440	320	60
Plasma Current (MA)	30	11	13	6.5
Fusion Power (MW)	3000	2200	2600	200
Fusion Power Density (MW/m^3)	3.7	6.2	12	12
Neutron Wall Load (MW/m^2)	4	4	6.4	3
COE Projected (mils/kWh)	81	76	≈50	

* preliminary result

Fusion Ignition Research Experiment (FIRE)

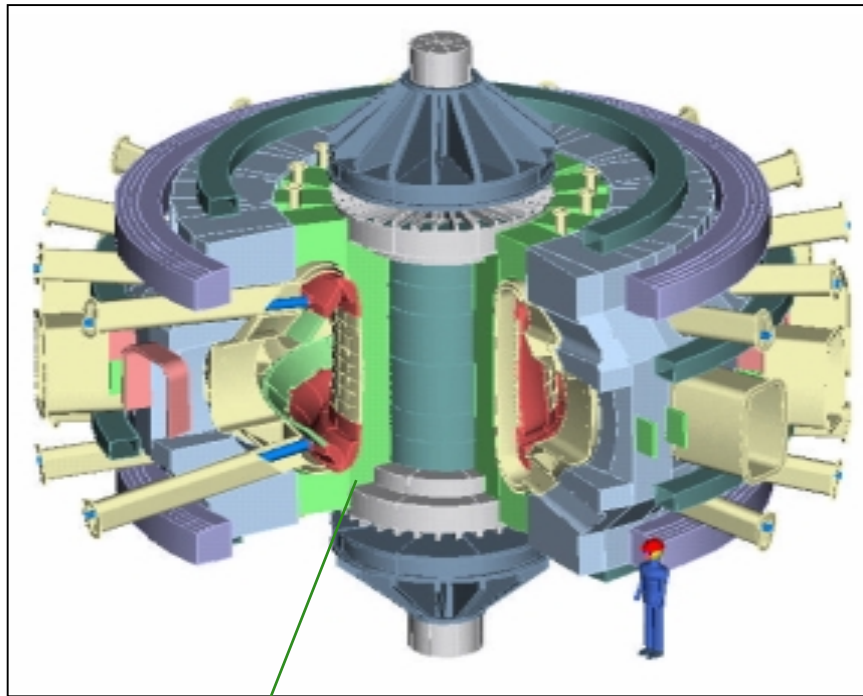

LN BeCu ("HTS")

Design Goals

- $R = 2.0 \text{ m}$, $a = 0.525 \text{ m}$
- $B = 10 \text{ T}$, (12T)*
- $W_{\text{mag}} = 3.8 \text{ GJ}$, (5.5 GJ)*
- $I_p = 6.5 \text{ MA}$, (7.7 MA)*
- $P_{\alpha} > P_{\text{aux}}$, $P_{\text{fusion}} \sim 220 \text{ MW}$
- $Q \sim 10$, $\tau_E \sim 0.55\text{s}$
- Burn Time $\sim 20\text{s}$ (12s)*
- Tokamak Cost $\leq \$0.3\text{B}$
Base Project Cost $\leq \$1\text{B}$

* Higher Field Option

Attain, explore, understand and optimize alpha-dominated plasmas to provide knowledge for the design of attractive MFE systems.

A Robust and Flexible Design for FIRE has been Achieved

- Toroidal and poloidal coil structures are independent allowing operational flexibility
 - The toroidal field coils are wedged with static compression rings to increase capability to withstand overturning moments and to ease manufacturing.
- 16 coil TF system with large bore provides
 - Large access ports (1.3m high by 0.7m wide) for maintenance and diagnostics.
 - Low TF ripple (0.3% at plasma edge) provides flexibility for lower current AT modes without large alpha losses due to ripple.
- Double-null divertor configuration for H-mode and AT modes with helium pumping that is maintainable/replaceable/upgradeable remotely
- Double wall vacuum vessel with integral shielding (ITER-like) to reduce neutron dose to TF and PF coils, and machine structure.
- Cooling to LN₂ allows full field (10T) flattop for 20s or 4T (TPX-like) flattop for 250s.

The FIRE Engineering Report and 16 FIRE papers presented at the IEEE Symposium on Fusion Engineering are available on the web at <http://fire.pppl.gov>

Basic Parameters and Features of FIRE Reference Baseline

R, major radius	2.0 m
a, minor radius	0.525 m
κ_{95} , elongation at 95% flux surface	~1.8
δ_{95} , triangularity at 95% flux surface	~0.4
q_{95} , safety factor at 95% flux surface	>3
Bt, toroidal magnetic field	10 T with 16 coils, < 0.5% ripple @ Outer MP
Toroidal magnet energy	3.7 GJ
I_p , plasma current	~6.5 MA (7.7 MA at 12 T)
Magnetic field flat top, burn time	21 s at 10 T, $P_{\text{fusion}} \sim 200$ MW)
Pulse repetition time	2 hr @ full field
ICRF heating power, maximum	30 MW, 100MHz for $2\Omega_T$, 4 mid-plane ports
Neutral beam heating	None, may have diagnostic neutral beam
Lower Hybrid Current Drive	None in baseline, upgrade for AT phase
Plasma fueling	Pellet injection (≥ 2.5 km/s vertical launch inside mag axis, possible guided slower speed pellets)
First wall materials	Be tiles, no carbon
First wall cooling	Inertial between pulses
Divertor configuration	Double null, fixed X point, detached mode
Divertor plate	W rods on Cu backing plate (ITER R&D)
Divertor plate cooling	Inner plate-inertial, outer plate active - water
Fusion Power/ Fusion Power Density	~200 MW, ~10 MW m ⁻³ in plasma
Neutron wall loading	~ 3 MW m ⁻²
Lifetime Fusion Production	5 TJ (BPX had 6.5 TJ)
Total pulses at full field/power	3,000 (same as BPX), 30,000 at 2/3 Bt and I_p
Tritium site inventory	Goal < 30 g, Category 3, Low Hazard Nuclear Facility

Design Option at B = 12T and I_p = 7.7MA with a 12 second flat top has been identified.

FIRE Incorporates Advanced Tokamak Innovations

AT Features

- DN divertor
- strong shaping
- very low ripple
- internal coils
- space for wall stabilizers
- inside pellet injection
- large access ports

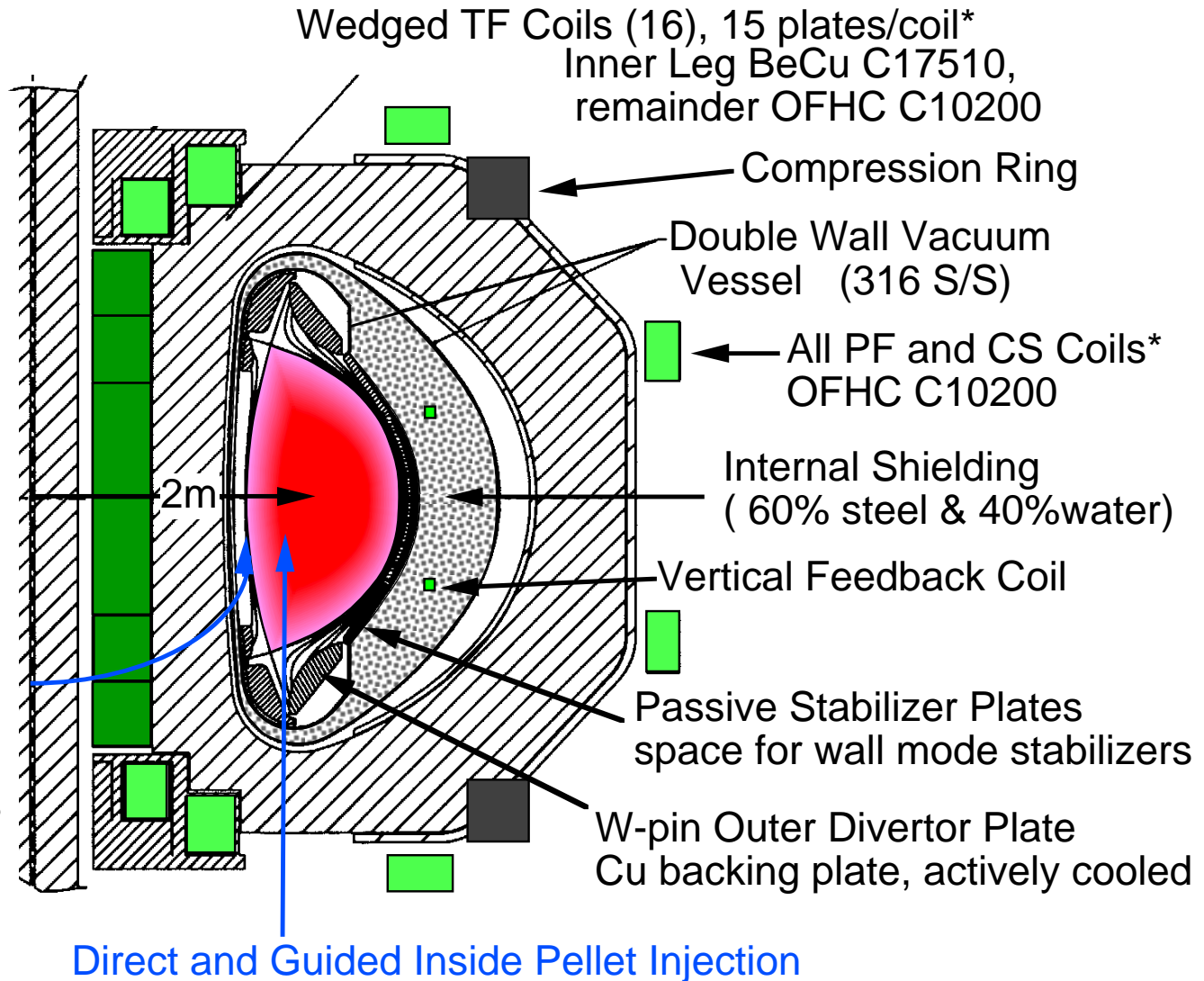

*Coil systems cooled to 77 °K prior to pulse, rising to 373 °K by end of pulse.

FIRE would have Access for Diagnostics and Heating

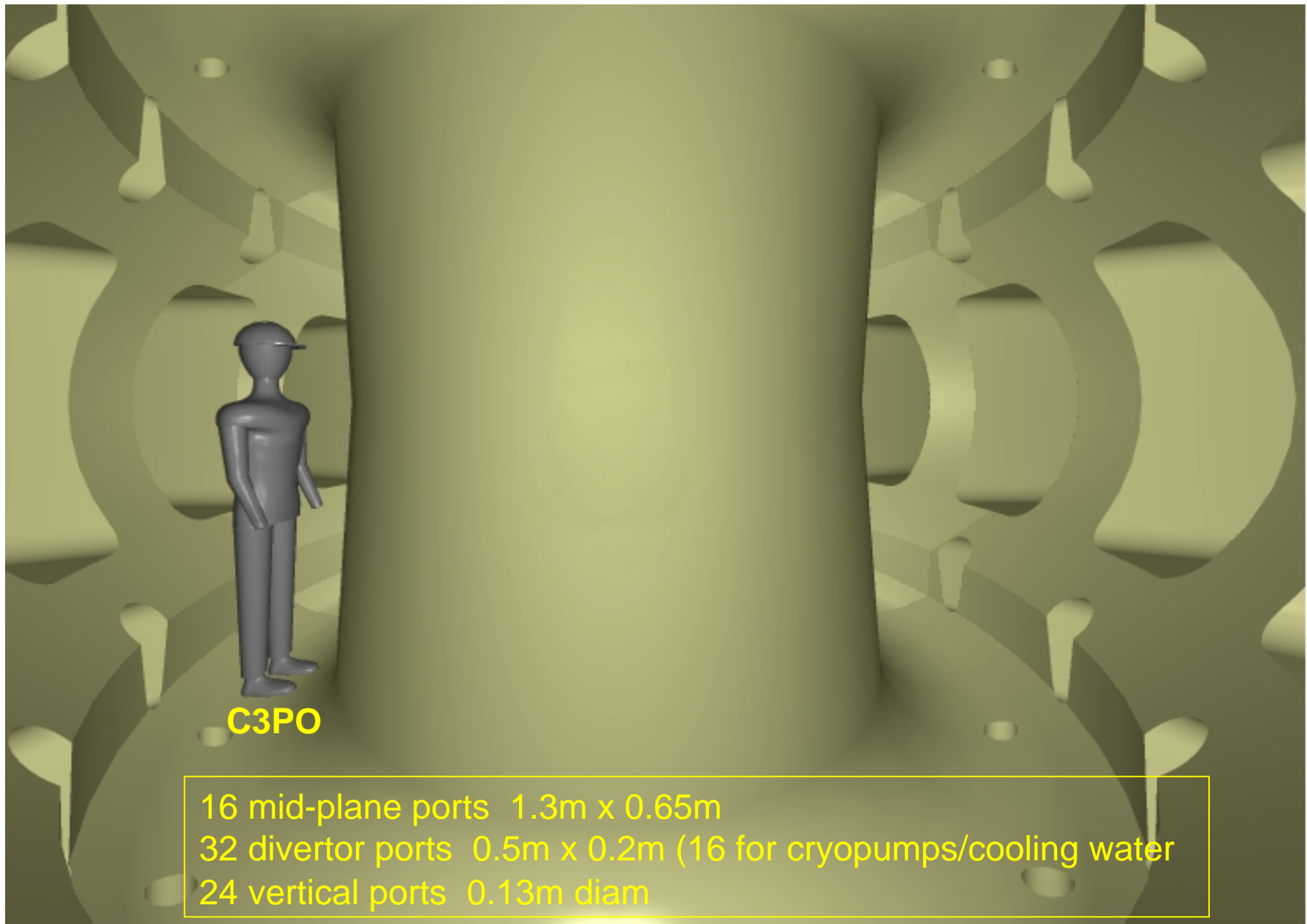

Q Must be Increased by ~50 for Sustained High-Gain(Q ~ 10) Burning Plasma Experiments

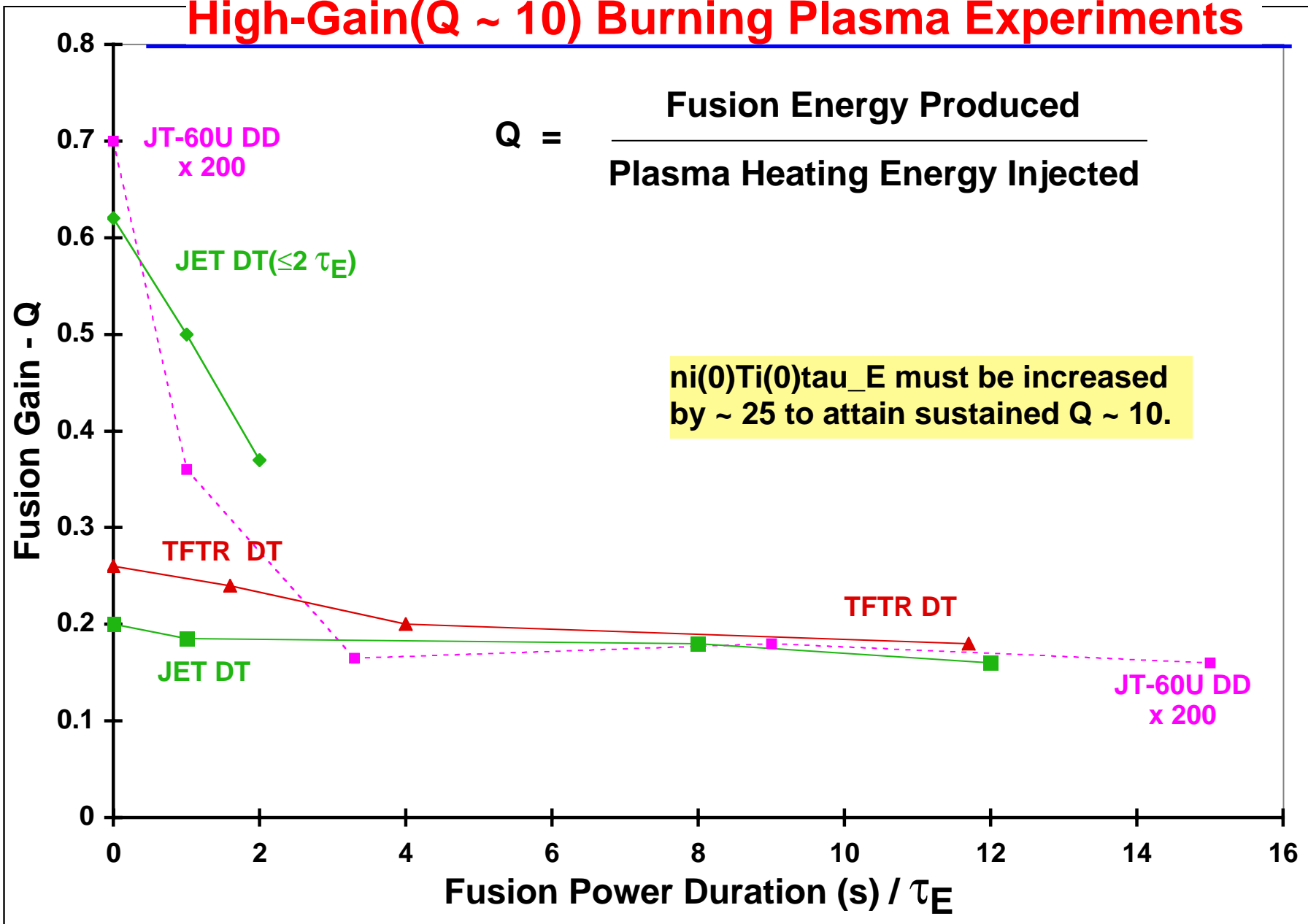

Recent Innovations have Markedly Improved the Technical Basis for a Compact High Field Tokamak Burning Plasma Exp't.

Tokamak experiments (1989-1999) have developed enhanced confinement modes that scale (e.g., ITER-98H) 1.3 times higher than the 1989 CIT design assumption.

Alcator C-Mod - the prototype for Compact High Field tokamaks has shown:

- Confinement in excess of 1.4 times the 1989 design guidelines for CIT and ~1.15 times the recent ITER-98H design guidelines.
- Successful ICRF heating at high density in shaped diverted plasmas
- Successful detached divertor operation at high power density

D-T experiments on TFTR and JET have shown:

- Tritium can be handled safely in a laboratory fusion experiment!!!
- D-T plasmas behaved roughly as predicted with slight improvements in confinement in plasmas with weak alpha-heating.

Engineering Innovations to increase capability and reduce cost

- Improved coil and plasma facing component materials, improved 3-D engineering computer models and design analysis, advanced manufacturing.

Guidelines for Estimating Plasma Performance

Confinement (Elmy H-mode) - Based on today's tokamak data base

$$\tau_E = 0.094 I^{0.97} R^{1.7} a^{0.23} n_{20}^{0.41} B^{0.08} A_i^{0.2} \kappa^{0.67} P_{\text{heat}}^{-0.63}$$

Density Limit - Base on today's tokamak data base

$$n_{20} \leq 0.75 n_{\text{GW}} = 0.75 I_p / \pi a^2, \quad H98 \approx 1 \text{ up to } 0.75 n_{\text{GW}} \text{ (JET, 1998)}$$

Beta Limit - theory and tokamak data base

$$\beta \leq \beta_N(I_p/aB), \quad \beta_N \sim 2.5 \text{ conventional, } \beta_N \sim 4 \text{ advanced}$$

H-Mode Power Threshold - Based on today's tokamak data base

$$P_{\text{th}} \geq (0.9/A_i) n^{0.75} B R^2, \quad \text{nominal L to H, with H to L being } \sim \text{half} \\ \text{when well below the density limit.}$$

Helium Ash Confinement $\tau_{\text{He}} = 5 \tau_E$, impurities = 3% Be

Understanding is mainly empirical. Better understanding is needed from existing experiments with improved simulations, and a benchmark in alpha-dominated fusion plasmas is needed for the design of an Fusion Energy Demonstration project.

Nominal FIRE Plasma Parameters from 0-D Simulations

R, plasma major radius, m	2.0
A, plasma minor radius, m	0.525
R/a , aspect ratio	3.8
κ_{95} , plasma elongation at 95% flux	1.77
δ_{95} , plasma triangularity at 95% flux	0.4
q ₉₅	3.02
B _t , toroidal magnetic field, T	10
I _p , plasma current, MA	6.44
l _{i(3)} , internal plasma inductance	0.8
Fraction of bootstrap current	0.25
Ion Mass, 50/50 D/T	2.5
$\langle n_e \rangle$, 10 ²⁰ /m ³ , volume average	4.5
α_n , density profile peaking = 1 + α_n	0.5
$\langle n \rangle / \text{Greenwald Density Limit}, \leq 0.75$	0.70
$\langle T \rangle_n$, density averaged temperature, keV	8.2
T(0), central temperature, keV	13.1
α_T , temperature profile peaking = 1 + α_T	1
Impurities, Be:high Z, %	3 : 0
Alpha ash accumulation, n _α /n _e , %	2.6
Z _{eff}	1.41
v*, collisionality at q = 1.5	0.043
P _{ext} , MW	22
P _{fusion} , MW	223
P _{heat} , MW	56.5
tau _p *(He)/tau _E	5.00
tau _E , energy confinement time s	0.57
ITER98H-multiplier, ≤ 1	1.04
ITER89P - Multiplier	2.41
n _d (0)T(0)τ _E , 10 ²⁰ m ⁻³ keVs	41.69
Q _{DT}	10.16
IA, MA	24.5
Plasma current redistribution time, s	13.9
P_{heat}/P(L->H), ≥ 1	1.149
W _p , plasma thermal energy, MJ	32.18
β _{total} , thermal plasma + alphas, %	3.11
β_N, ≤ 2.5	2.54
Core Plasma Pressure, atmospheres	~ 20

* ARIES-AT, Q = 45 at HH = 1.3

FIRE can Access High Gain in Elmy H-Mode

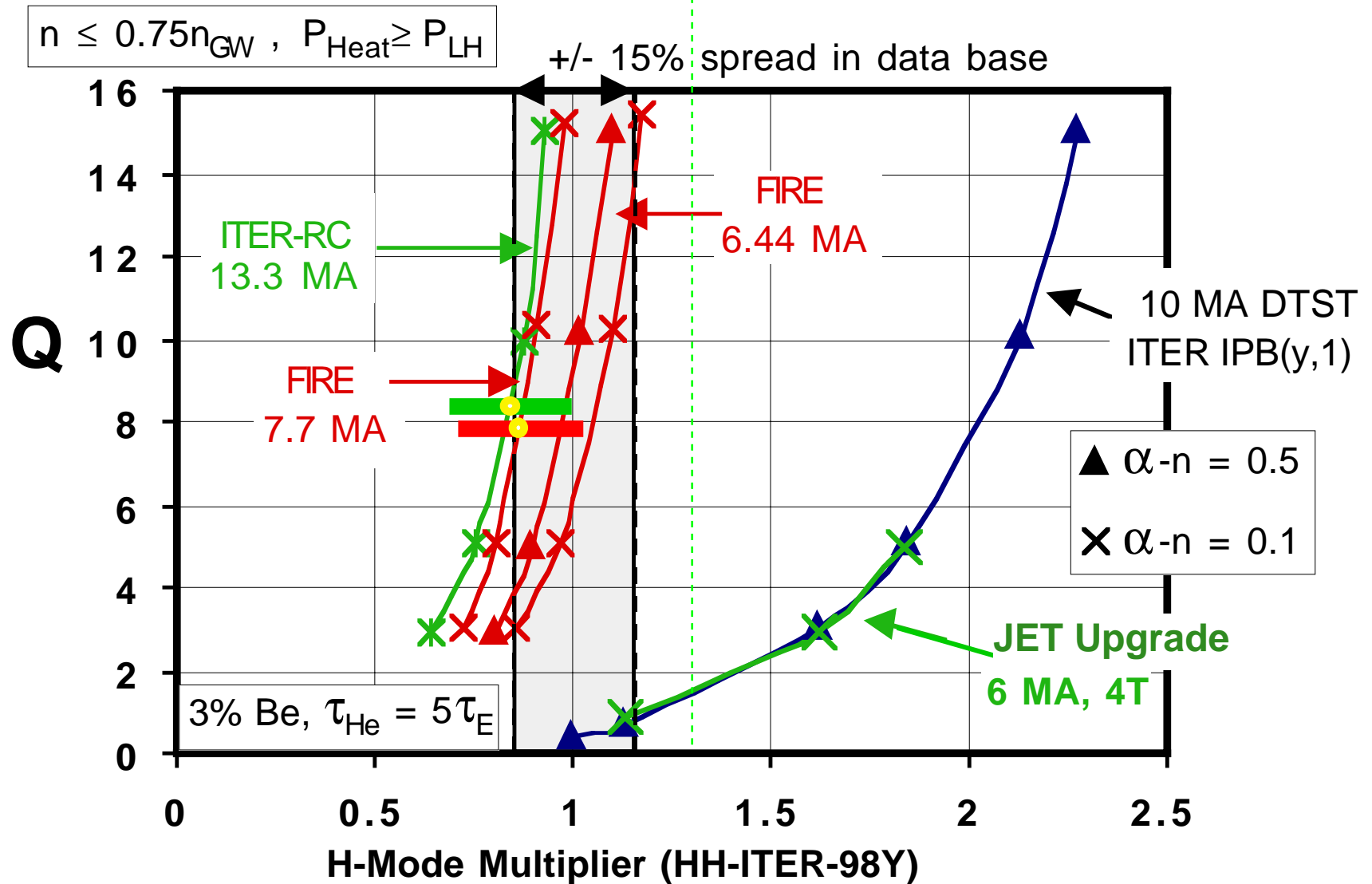

The baseline FIRE (6.44 MA) can access the alpha-dominated regime ($Q > 5$) for $HH = 1$.

The Energy Mission is vulnerable to uncertainties in confinement.

FIRE can Access Alpha-Dominated Plasmas in H-Mode

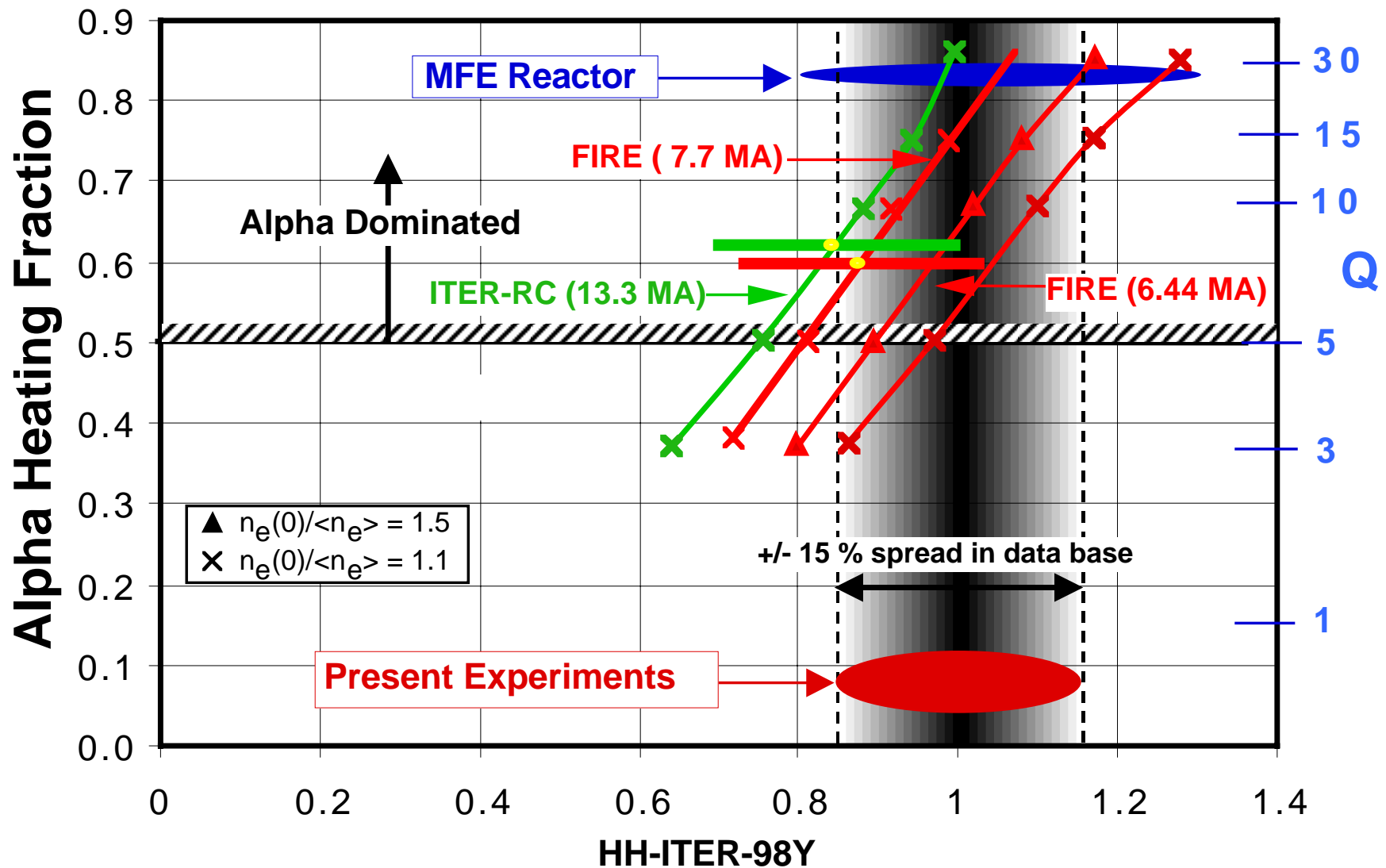

The Science Mission is robust to uncertainties in confinement.

1 1/2 -D Simulation* of Burn Control in FIRE

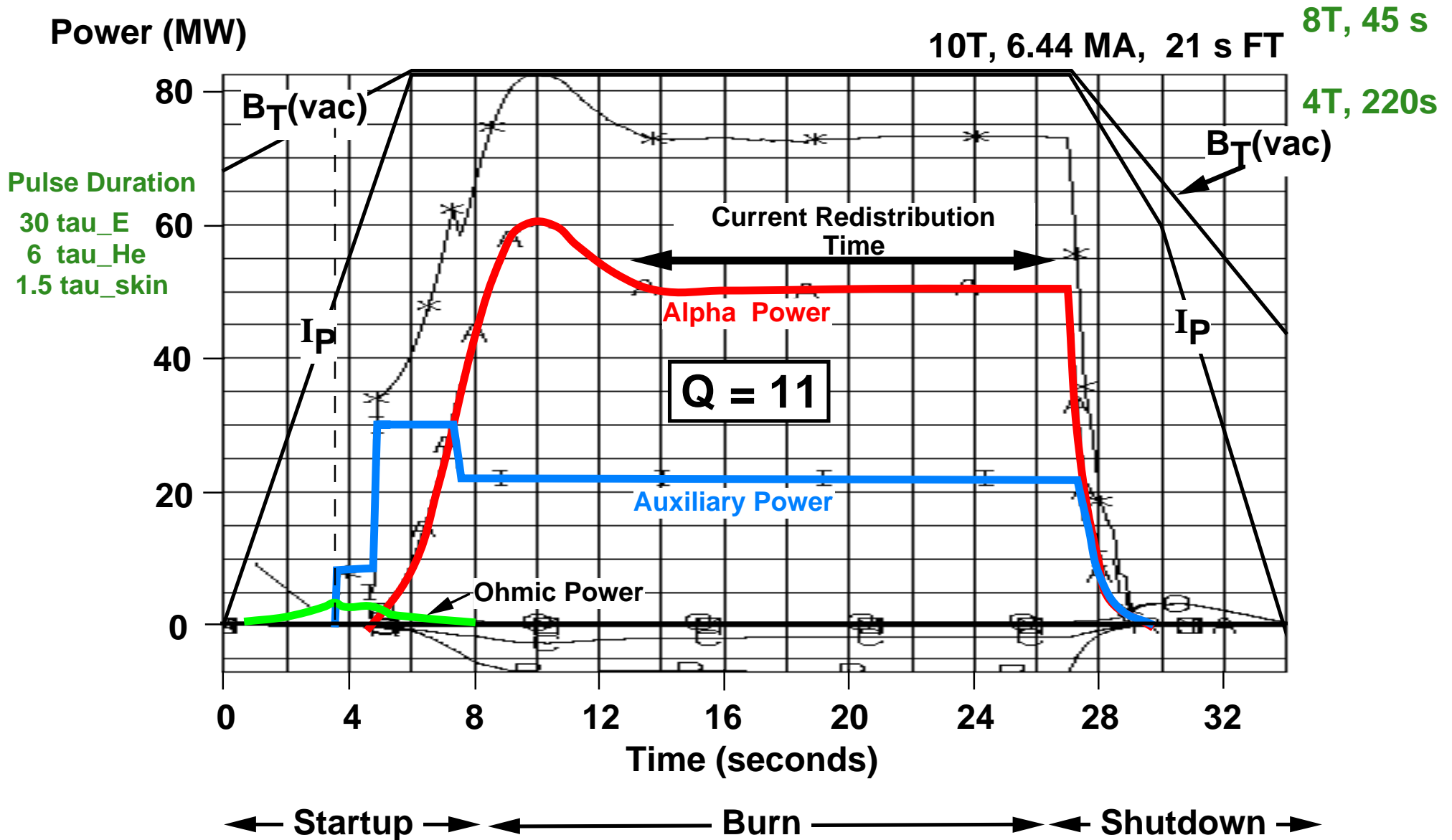

* The Tokamak Simulation Code (TSC) is one of several plasma simulation codes. [Click here http://w3.pppl.gov/topdac/](http://w3.pppl.gov/topdac/)

Helium Ash Accumulation can be Explored on FIRE

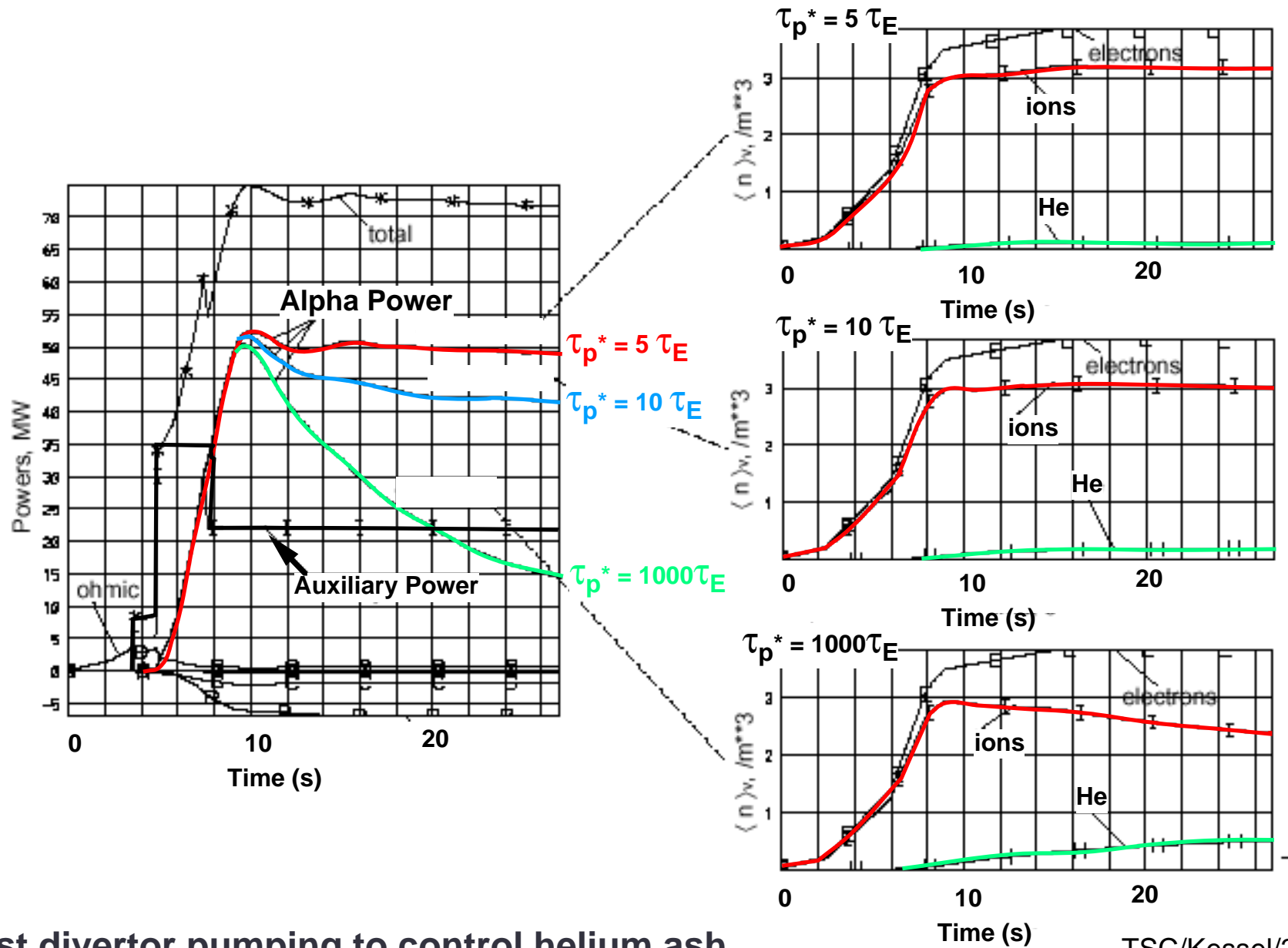

Adjust divertor pumping to control helium ash

FIRE could Access High-Gain Advanced Tokamak Regimes for Long Durations

- The coupling of advanced tokamak modes with strongly burning plasmas is a generic issue for all advanced “toroidal” systems. The VLT PAC, Snowmass Burning Plasma and Energy Subgroup B recommended that a burning plasma experiment should have AT capability.
- FIRE, with strong plasma shaping, flexible double null poloidal divertor, low TF ripple, dual inside launch pellet injectors, and space reserved for the addition of current drive (LHCD) and/or a smart conducting wall, has the capabilities needed to investigate advanced tokamak regimes in a high gain burning plasma.
- The LN inertially cooled TF coil has a pulse length capability ~ 250 s at 4T for DD plasmas. This long pulse - AT capability rivals that of any existing divertor tokamak or any under construction. **The coils are not the limit.**
- Recent AT regimes on DIII-D (Shot 98977) sustained for $\sim 16 \tau_E$ serve as demonstration discharges for initial AT experiments on FIRE. Need to develop self-consistent scenarios with profile control on FIRE with durations $\sim 3 \tau_{\text{skin}}$.

FIRE can Access “Long Pulse” Advanced Tokamak Modes at Reduced Toroidal Field.

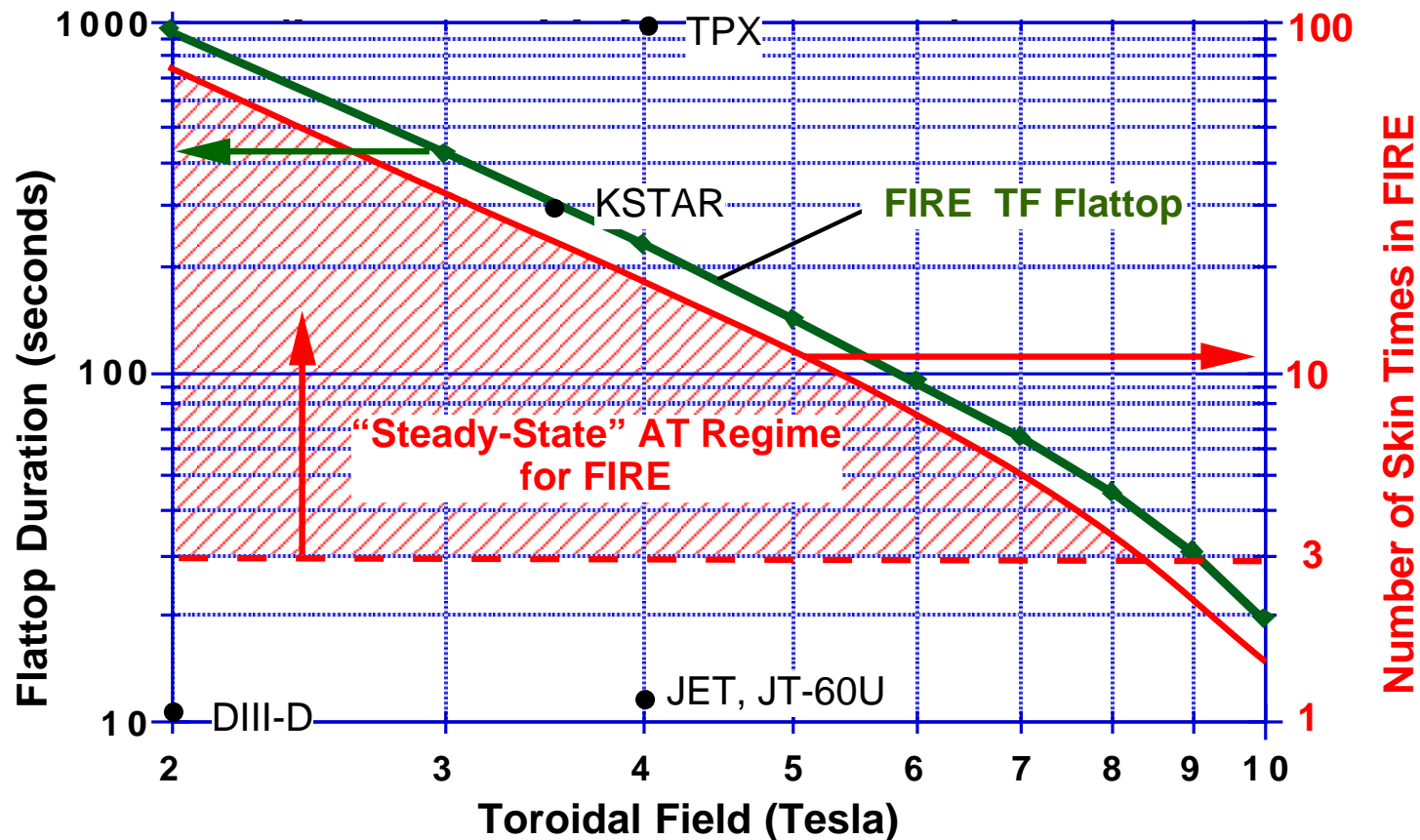

Note: FIRE is \approx the same size as TPX and KSTAR.
 At $Q = 10$ parameters, typical skin time in FIRE is 13 s and is 200 s in ITER-RC .

The combination of KSTAR and FIRE could cover the range from steady-state non-burning advanced-tokamak modes to “quasi-equilibrium” burning plasmas in advanced tokamak modes.

FIRE can Access MHD Regimes of Interest from Today's Data Base to those Envisioned for ARIES-RS

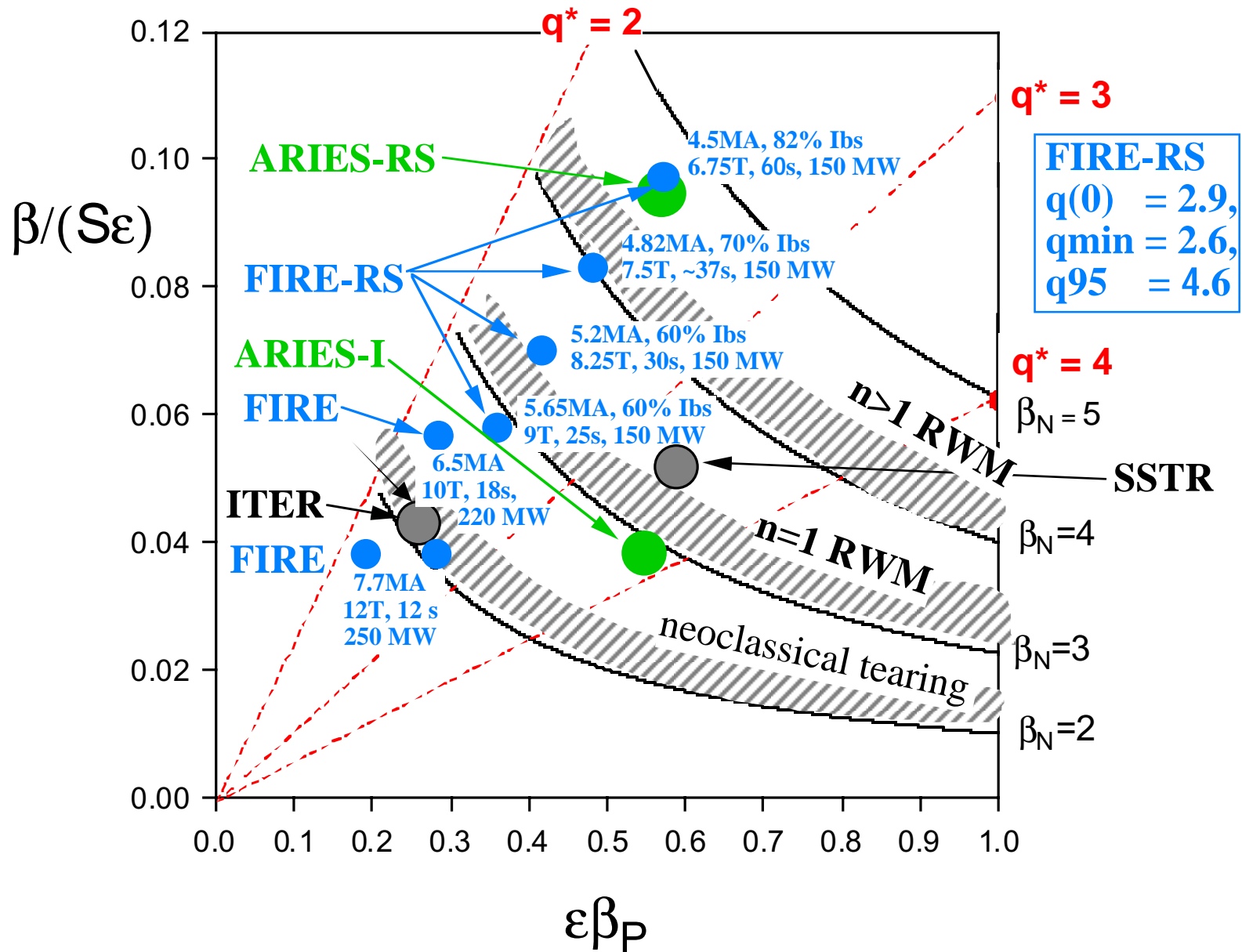

FIRE can Test Advanced Regimes of Relevance to ARIES-AT

Confinement
Required
to access
this regime

$Q = 10,$
 $HH = 1.2$

or

$Q = 5,$
 $HH = 1.06$

Duration

$\sim 2 \tau_{skin}$

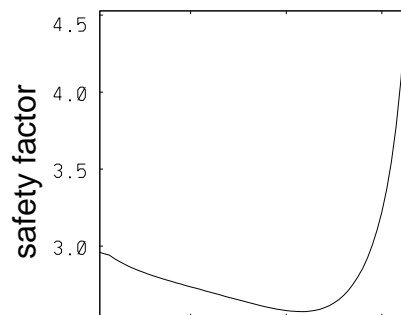
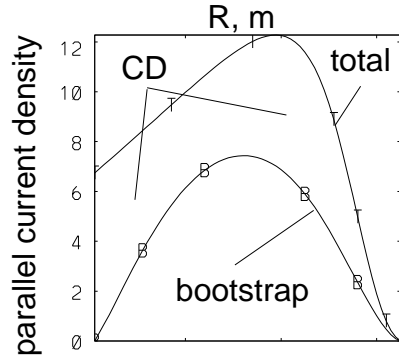
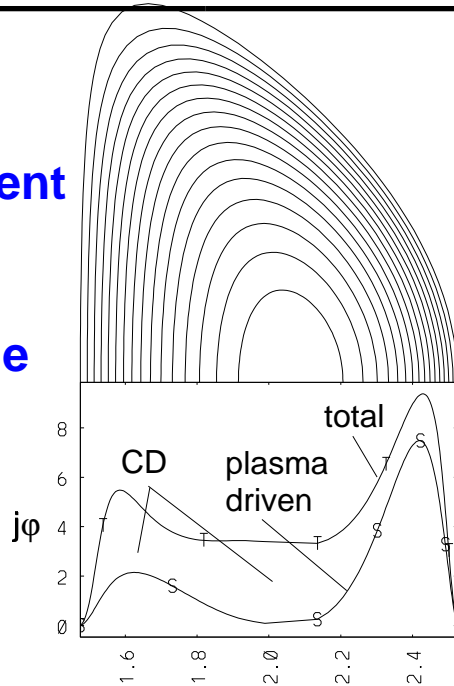

Case 1
Modest
AT

30	Flat top(s)	60
5.65	I_p (MA)	4.50
9.00	B_T (T)	6.75
2.90	q_0	2.90
2.60	q_{min}	2.60
1.31	β_p	2.11
2.60	β_N	4.50
3.10	$\beta(\%)$	5.70
0.42	li	0.39
0.50	f_{bs}	0.82
165	P_{fus} (MW)	170
29.4	W_{th} (MJ)	30.1
0.65	n_e/n_{Gr}	0.81
2.40	α -loss(%)	9.40

Case 4
Strong
AT

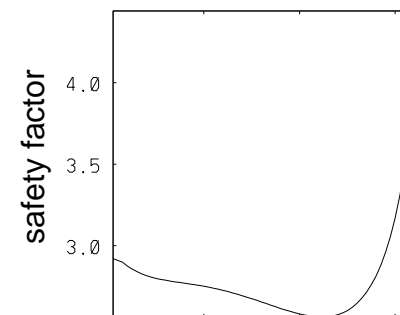
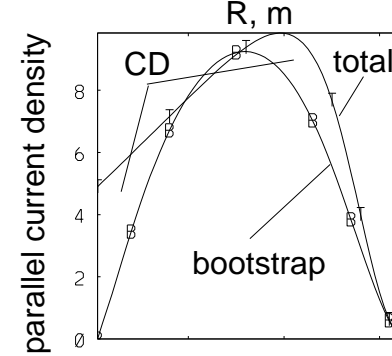
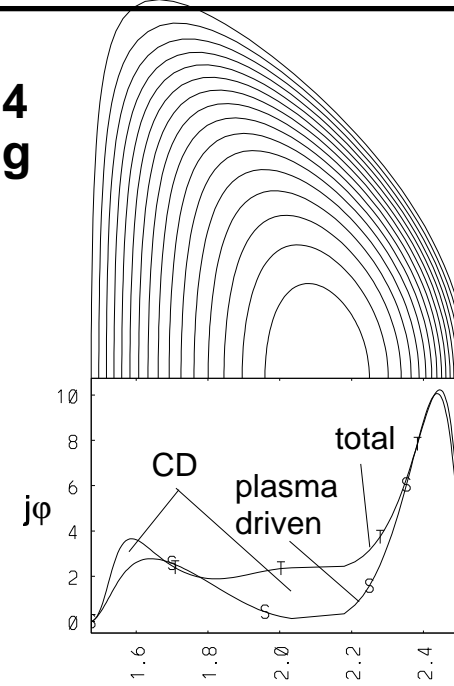

Confinement
Required
to access
this regime

$Q = 10,$
 $HH = 1.56$

or

$Q = 5,$
 $HH = 1.36$

Duration

$\sim 4 \tau_{skin}$

The transport calculations assumed 150 MW of fusion power and $n(0)/\langle n \rangle = 1.5$.

Long-Pulse Advanced Tokamak Performance Achieved in DIII-D Leads to Interesting High-Gain Advanced Burning Plasma Experiments

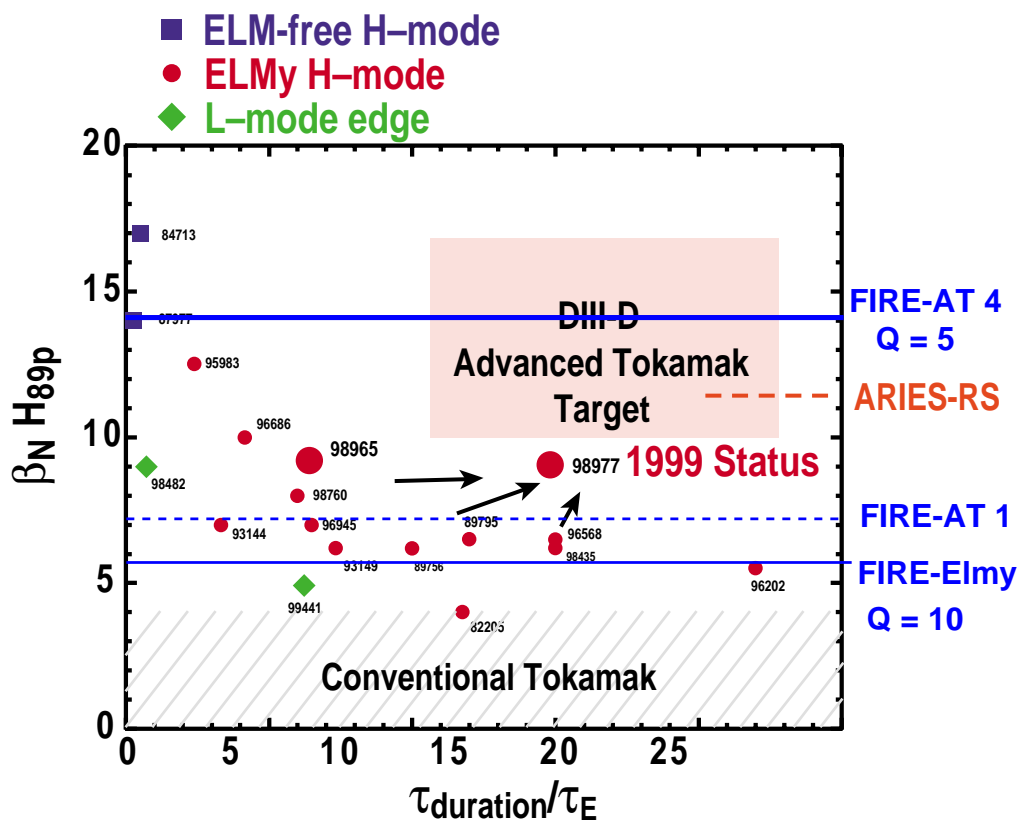

FIRE-Elmy is conventional Elmy H-Mode
 FIRE-AT 1 is modest AT with 50% fbs and $\beta_N = 2.6$
 FIRE-AT 4 is strong AT with 82% fbs and $\beta_N = 4.5$

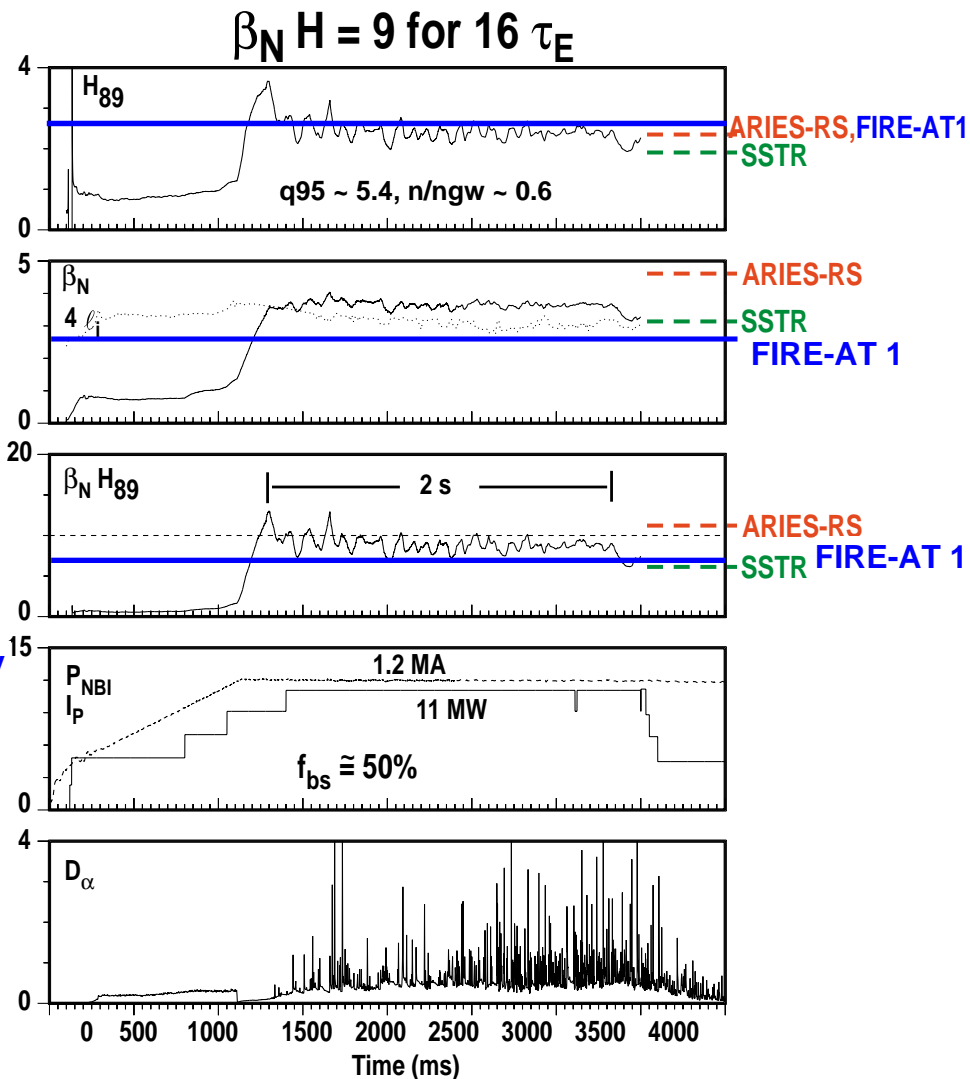

DIII-D shot 98977 is close to a Demonstration Discharge for FIRE-AT 1
 FIRE-AT 1 requires $q_{95} = 4.5, n/ngw = 0.65, \beta_N H_{89} = 7.1$, and
 produces $f_{bs} = 50\%$ and $Q = 10$ ($P_{fusion} = 150$ MW, $P_{in} = 15$ MW). This
 mode would be useful for quasi-steady experiments ~ 2 skin times.

Potential Next Step Burning Plasma Experiments and Demonstrations in MFE

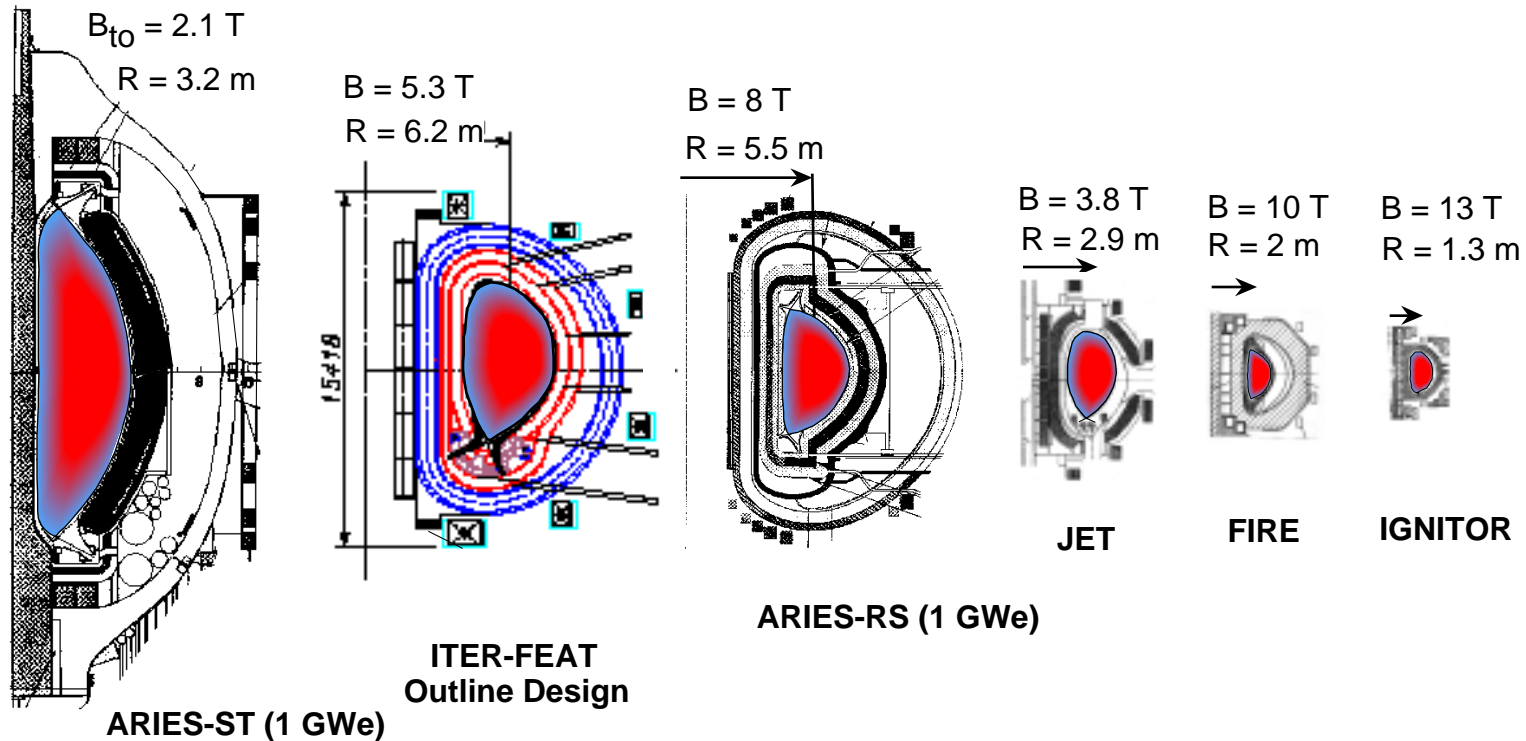

Cost Drivers	ARIES-ST	ITER-FEAT	ARIES-RS	JET	FIRE	IGNITOR
Plasma Volume (m ³)	810	837	350	95	18	11
Plasma Surface (m ²)	580	678	440	150	60	36
Plasma Current (MA)	28	15	11	4	6.5	12
Magnet Energy (GJ)	29	50	85	2	5	5
Fusion Power (MW)	3000	500	2200	16	200	100
Burn Time (s), inductive	steady	300	steady*	1	20	5

* assumes non-inductive current drive

Status of FIRE Costing Activity (12/12/99)

- Preliminary input from subsystem engineers (k\$)

Tokamak	\$284,500
Ancillary	\$157,039
Power	\$235,000
Facility	\$206,035
Project Support	\$180,412
<hr/>	
Total	\$1,063,006* (k\$)

*FY2000\$ without contingency

- The initial estimates are being reviewed to eliminate double counting and include missing cost elements.
- The cost estimate will be available for external review by mid-July.

Timetable for Burning Plasma Experiments

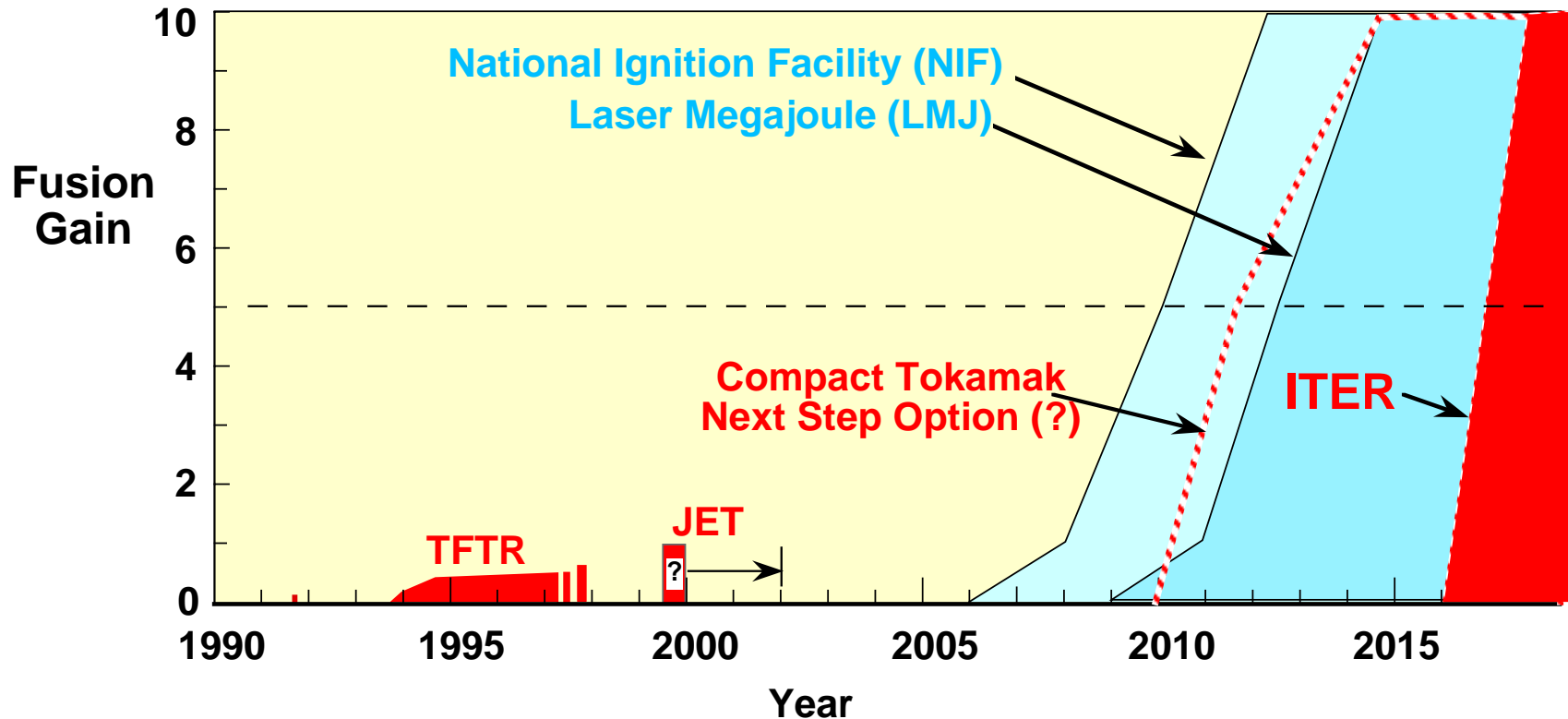

- Even with ITER, the MFE program would be unable to address the burning plasma issues in alpha-dominated ($Q > 5$) plasmas for ≥ 15 years.
- Compact High-Field Tokamak Burning Plasma Experiment(s) would be a natural extension of the ongoing “advanced” tokamak program and could begin alpha-dominated experiments by ~ 2010 .
- The information “exists now” to make a quantitative technical assessment, and decision on MFE burning plasma experiments for the next decade.

Basic Strategy for an Advanced Tokamak Next Step (FIRE)

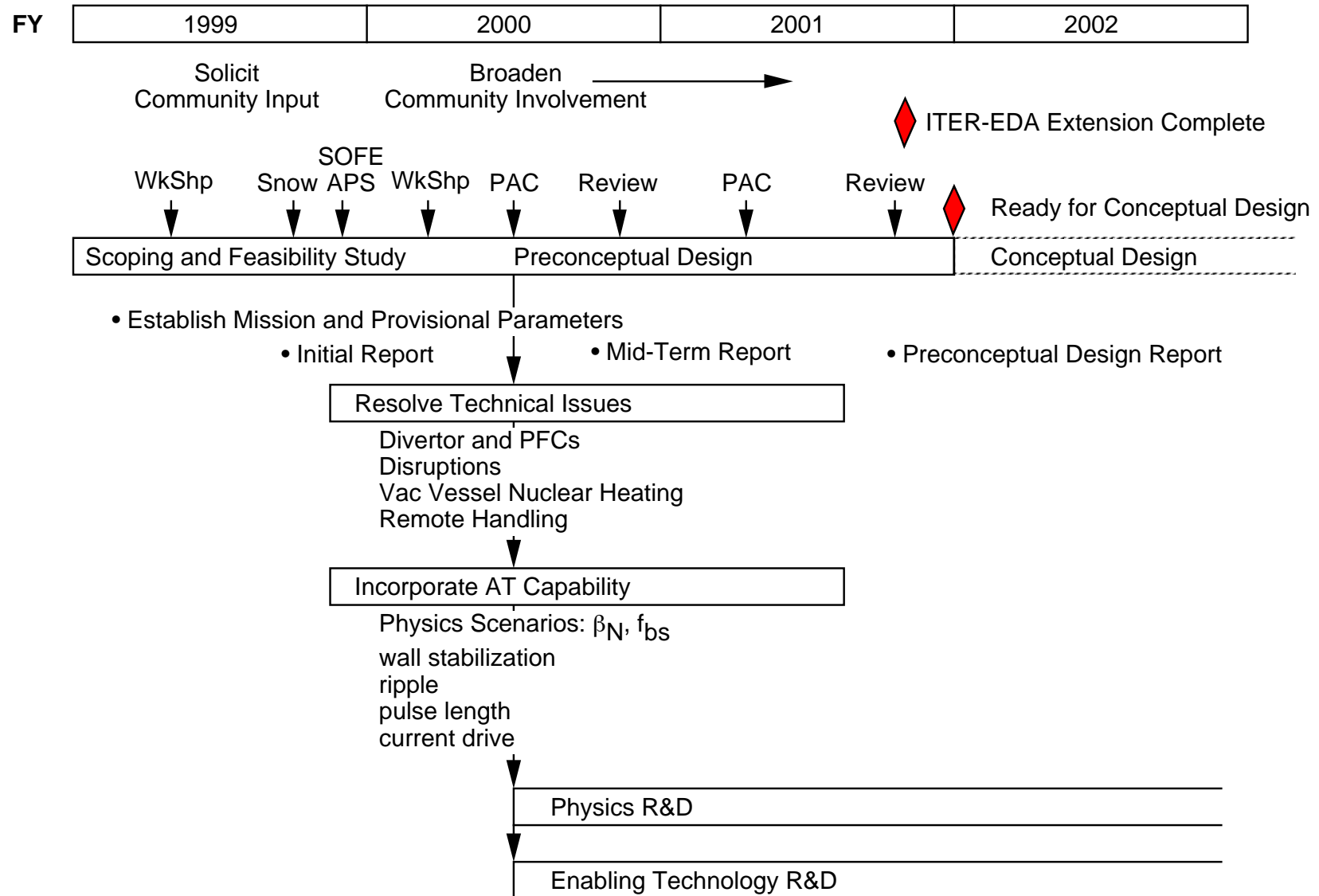

Critical Issues for FIRE and Magnetic Fusion

The critical physics and engineering issues for FIRE are the same as those for fusion, the goal of FIRE is to help resolve these issues for magnetic fusion. The issues and questions listed below need to be addressed in the near future.

- Physics
 - confinement - H-mode power threshold, edge pedestal, AT modes,
 - stability - NTMs, RWM, disruptions: conducting wall? feedback coils? VDE?
 - heating and current drive - ICRF is baseline: NBI & LHCD as upgrades?
 - boundary - detached divertor operation, impurity levels, confinement
 - self-heating - fast alpha physics and profile effects of alpha heatingDevelopment of self-consistent self-heated AT modes with external controls
- Engineering
 - divertor and first wall power handling (normal operation and disruptions)
 - divertor, first wall and vacuum vessel for long pulse AT modes
 - evaluate low inventory tritium handling possibilities
 - complete many engineering details identified in FIRE Engineering Report
 - evaluate potential sites for Next Step MFE experiment
 - complete cost estimate for baseline, identify areas for cost reduction

Major Conclusions of the FIRE Design Study

- Exploration, understanding and optimization of alpha-dominated (high-gain) burning plasmas are critical issues for all approaches to fusion.
- The tokamak is a cost-effective vehicle to investigate alpha-dominated fusion plasma physics and its coupling to advanced toroidal physics for MFE. The tokamak is technically ready for a next step to explore fusion plasma physics.
- The FIRE compact high field tokamak can address the important alpha-dominated plasma issues, many of the long pulse advanced tokamak issues and begin the integration of alpha-dominated plasmas with advanced toroidal physics in a \$1B class facility.
- The FIRE design point has been chosen to be a “stepping stone” between the physics accessible with present experiments and the physics required for the ARIES vision of magnetic fusion energy.
- A plan is being developed for an Advanced Tokamak Next Step that will address physics, engineering and cost issues in FY 2000-1 with the goal of being ready to begin a Conceptual Design in 2002.